

S 301

1225 €

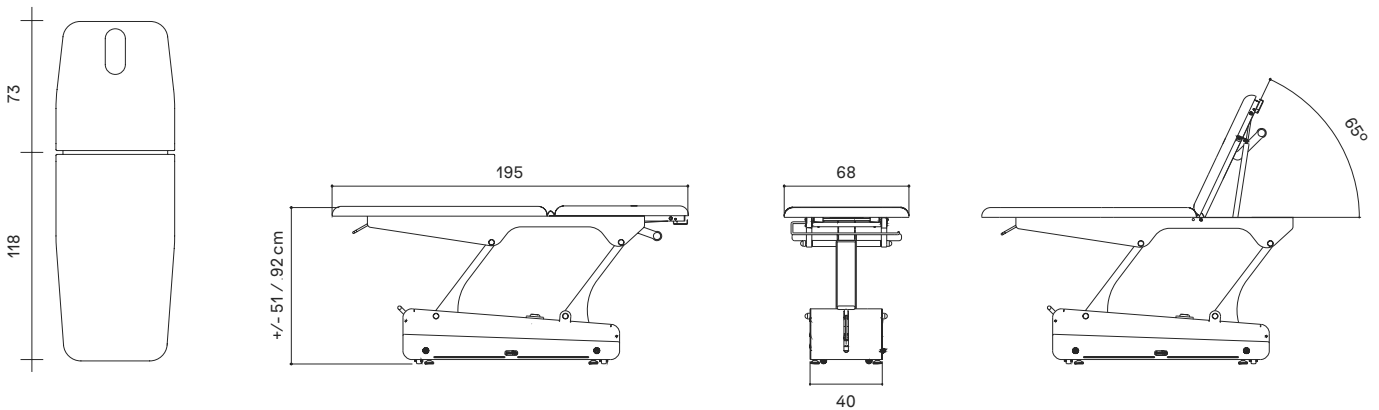

Abmessungen



Technische Angaben

MOTOREN
1 Motor (Höhe)

ABMESSUNGEN (LÄNGE X BREITE)
195 x 68 cm

HÖHE (MIN. UND MAX.)
51/92 cm

GEWICHT
92 kg

POLSTERDICKE
6 cm

DICHTE
30 kg/m³

BELASTBARKEIT
175 kg

BEDIENUNG
Handfernbedienung (serienmäßige Ausstattung)/
Fußfernbedienung (optional)

STROMVERSORGUNG
230 V - 50/60 Hz

MAX. INTENSITÄT
2 A

ELEKTRISCHER MOTOR
6.000 N

POLSTERUNG

Nahtloser Polsterbezug und mit abgerundeten Kanten

100% Vinyl-Beschichtung

Permablok 3 Advanced Vinyl Protection (gegen Keime und Abrieb), UV-beständig, hohe Beständigkeit 300K, graue Farbe

Permaguard Advanced Vinyl Protection (gegen Keime und Abrieb), UV-beständig, hohe Beständigkeit 100K, weiße Farbe

Unsere Produkte



Medical Examination

S301



Swop 301 ist eine multifunktionale, elektrische Behandlungsliege

Holz, Metall oder PMMA



Kollektionen

Nordic
METALL

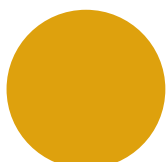

Yellow



Blue

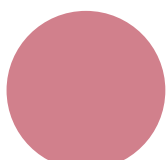

Pink

Foll
METALL

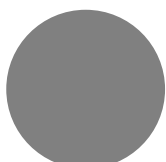

Ash

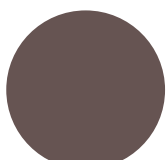

Clay

Iron
METALL

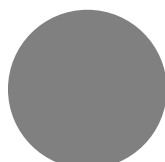

Inox

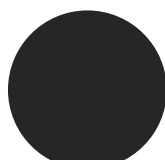

Black

Om
HOLZ



Oak



Wenge

Techno
PMMA



Fluor

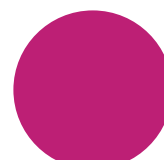

Fuxia



Ice